







ANLY PHOTO SENSOR

PG-47/67 PHOTOMICROSENSOR



- * Series includes models that enable switching between N.O. or N.C. operation
- * Response frequency as high as 1kHz
- * Easy operation monitoring with bright light indicator
- * Wide operating voltage range : 5~24VDC
- * Models in which the light indicator turns ON for dark-ON operation are also available
- * A wide range of variations in four different shapes
- * Flexible robot cable is provided as a standard feature

TYPE SELECTION :

Appearance	Sensing method	Sensing distance	Connecting method	Operating mode	Indicator mode	Model			
						NPN output	PNP output		
Standard 	Through-beam type (with slot)	5mm (slot width)	Connector (4 poles)	N.O. / N.C. (selectable)	Light-ON	PG-670NL	PG-670PL		
					Dark-ON	PG-670ND	PG-670PD		
			Connector (3 poles)	N.O.	Light-ON	PG-470NL1	PG-470PL1		
					Dark-ON	PG-470ND1	PG-470PD1		
Connector (3 poles)			N.C.	Light-ON	PG-470NL2	PG-470PL2			
				Dark-ON	PG-470ND2	PG-470PD2			
L-shaped 			Through-beam type (with slot)	5mm (slot width)	Connector (4 poles)	N.O. / N.C. (selectable)	Light-ON	PG-671NL	PG-671PL
							Dark-ON	PG-671ND	PG-671PD
	Connector (3 poles)	N.O.			Light-ON	PG-471NL1	PG-471PL1		
					Dark-ON	PG-471ND1	PG-471PD1		
Connector (3 poles)	N.C.	Light-ON			PG-471NL2	PG-471PL2			
		Dark-ON			PG-471ND2	PG-471PD2			
T-shaped, slot center 7mm 	Through-beam type (with slot)	5mm (slot width)			Connector (4 poles)	N.O. / N.C. (selectable)	Light-ON	PG-672NL	PG-672PL
							Dark-ON	PG-672ND	PG-672PD
			Connector (3 poles)	N.O.	Light-ON	PG-472NL1	PG-472PL1		
					Dark-ON	PG-472ND1	PG-472PD1		
Connector (3 poles)			N.C.	Light-ON	PG-472NL2	PG-472PL2			
				Dark-ON	PG-472ND2	PG-472PD2			
Close-mounting 			Through-beam type (with slot)	5mm (slot width)	Connector (4 poles)	N.O. / N.C. (selectable)	Light-ON	PG-674NL	PG-674PL
							Dark-ON	PG-674ND	PG-674PD
	Connector (3 poles)	N.O.			Light-ON	PG-474NL1	PG-474PL1		
					Dark-ON	PG-474ND1	PG-474PD1		
Connector (3 poles)	N.C.	Light-ON			PG-474NL2	PG-474PL2			
		Dark-ON			PG-474ND2	PG-474PD2			

SPECIFICATION :

Sensing distance	5mm(slot width)	
Sensing object	Opaque: 2 x 0.8mm min.	
Differential distance	0.025mm	
Light source	GaAs infrared LED with a peak wavelength of 940nm	
Indicator	Light indicator (orange)(turn ON when light is interrupted for models with D)	
Supply voltage	5~24VDC \pm 10%, ripple (p-p): 10% max.	
Current consumption	35mA max. (NPN models), 30mA max. (PNP models)	
Control output	NPN open collector: 5~24VDC, 100mA max. 100mA load current with a residual voltage of 0.8V max. 40mA load current with a residual voltage of 0.4V max.	
	PNP open collector: 5~24VDC, 50mA max. 50mA load current with a residual voltage of 1.3V max.	
Response frequency *1	1kHz min. (3kHz average)	
Ambient temperature range	Operating: -25~+55°C, Storage: -30~+80°C(with no icing or condensation)	
Ambient humidity range	Operating: 5%~85%, Storage: 5%~95%(with no icing or condensation)	
Degree of protection	IEC60529 IP50	
Connecting method	Connector Models (direct soldering possible)	
Weight	Standard app. 3.2g, L-shaped app. 2.8g, T-shaped/close-mounting app. 2.6g	
Material	Case	Polybutylene phthalate(PBT)
	Cover	Polycarbonate
	Emmitter/Receiver	

*1.The response frequency was measured by detecting the rotating disk shown at the right.

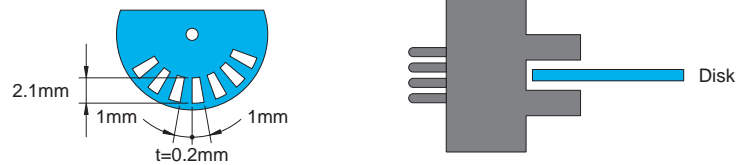

CONNECTION :

4 poles NPN model

N.O. : Open between ① and ② terminal
N.C. : Short-circuited between ① and ② terminal

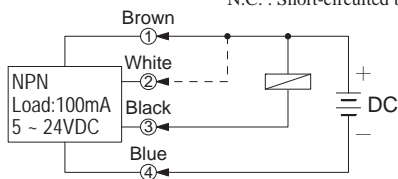

4 poles PNP model

N.O. : Open between ① and ② terminal
N.C. : Short-circuited between ① and ② terminal

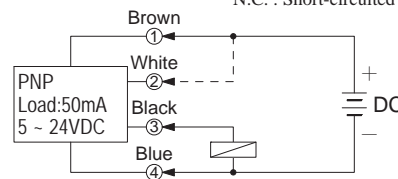

3 poles NPN model

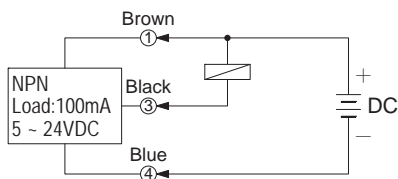

3 poles PNP model

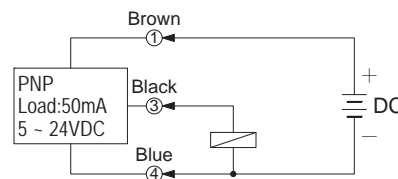

Terminal Arrangement

1	+	Vcc	Brown
2	L	L	White
3	OUT	OUTPUT	Black
4	-	GND(0V)	Blue

DIMENSIONS : (mm)

Standard

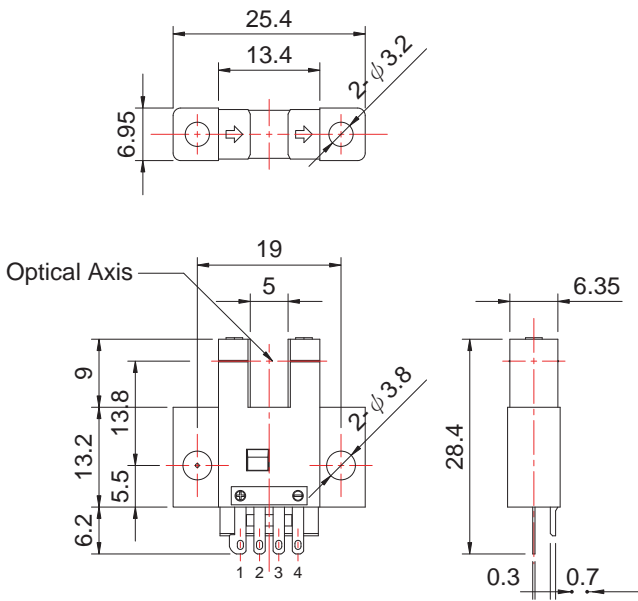

L-shaped

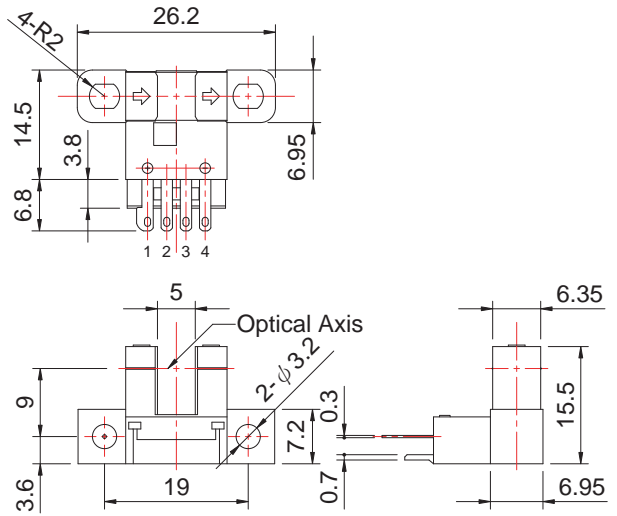

T-shaped

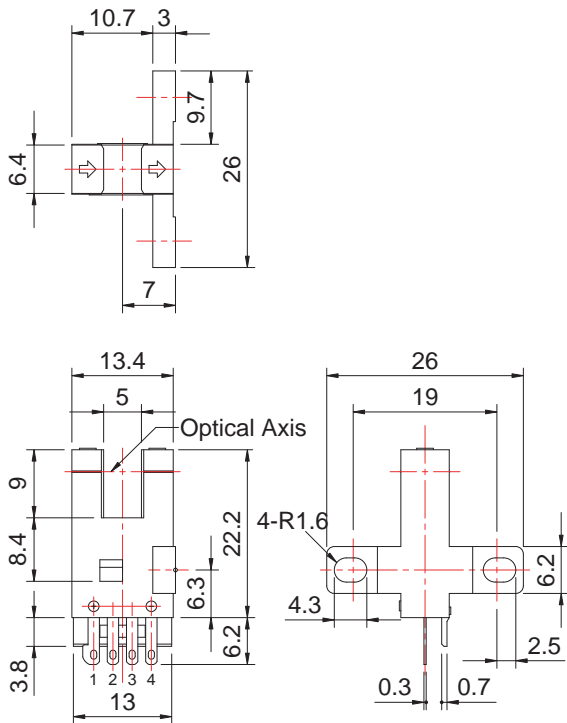

Close-mounting

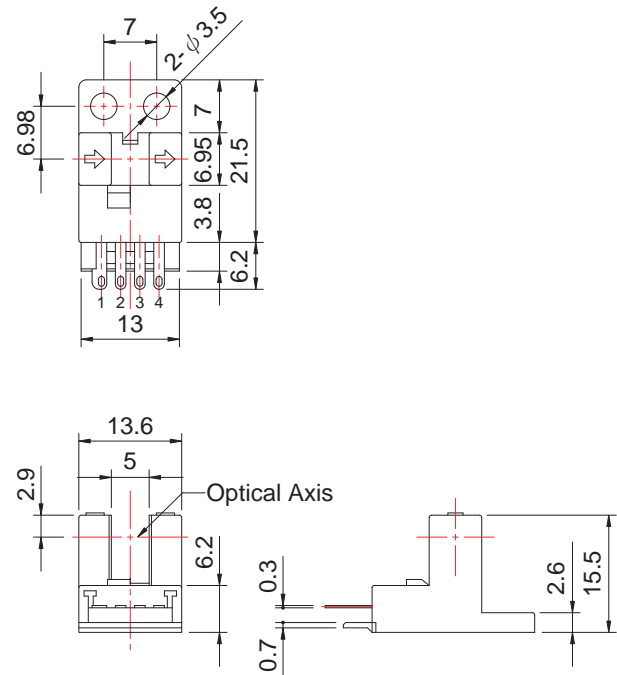

ACCESSORY : (option)

Connector

Model PG-P001

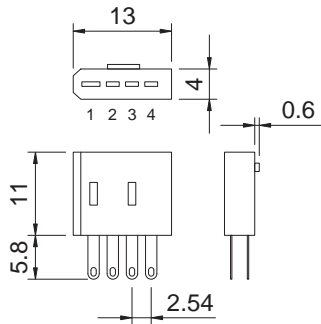

Connector with cable

Model PG-P201 - cable length 2m

Model PG-P301 - cable length 3m

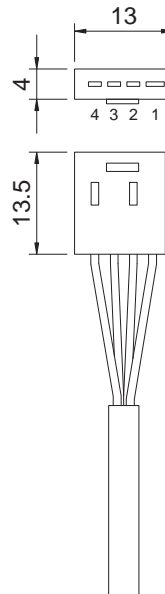

ANLY ELECTRONICS CO., LTD.

<http://www.anly.com.tw>

TAIWAN MAIN OFFICE : ANLY ELECTRONICS CO., LTD.

No.19, Lane 202, Fushou St., Xinzhuang Dist., New Taipei City 242, Taiwan
TEL: +886-2-2996-3202 FAX: +886-2-2996-2017

HONG KONG OFFICE : ANLY ELECTRONICS (HK) LTD.

Flat K, 13/F, Edward Mansion, 141 Prince Edward Road W., Kowloon, Hong Kong
TEL: +852-2397-2505 FAX: +852-2397-6080

CHINA OFFICE : ANLY TECHNOLOGY (WUXI) CO., LTD.

2F, Building A, Plot 1, No. 28, Zhanhong Rd., Xinwu Dist., Wuxi, Jiangsu, P.R.China
TEL: +86-510-85304801~3

MALAYSIA OFFICE : JUSTY ELECTRONICS (M) SDN, BHD.

No.1, Jalan 6/89B, Kawasan Perindustrian Trisegi, Batu 3 1/2 Off Jalan Sungei Besi, 57100 Kuala Lumpur, Malaysia
TEL: +60-3-7983-5758 FAX: +60-3-7981-5052

INDONESIA OFFICE : PT. ANLY ELECTRONICS INDONESIA

Jl. Pangeran Jayakarta 117/B9, Jakarta Pusat, 10730 Indonesia
TEL: +62-21-624-8436 FAX: +62-21-626-1228

NO. PG-W-A